

Ktronic Line of Locks

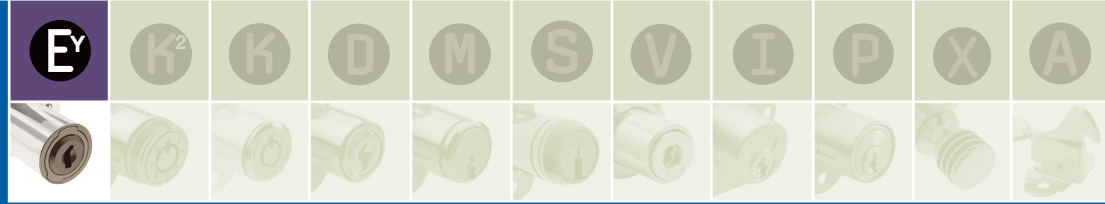

Introduction	$\frac{EY}{1}$				
Cam Locks	$\frac{EY}{2}$ $\frac{EY}{3}$				
Drawer/Door Locks	$\frac{EY}{4}$				
Gang Lock	$\frac{EY}{5}$				
Snap Bolt Lock	$\frac{EY}{6}$				
Plunger Locks	$\frac{EY}{7}$ $\frac{EY}{8}$ $\frac{EY}{9}$				
Padlock/Activation Plug/MFS	$\frac{EY}{10}$				
Key/Other	$\frac{EY}{11}$				

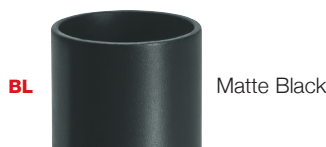
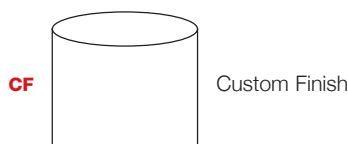

*New***Kenstan's Ktronic Line****Standard Plating Finish***** Special Plating Finishes***** Custom Plating Finish**

The Ktronic Line is a contactless electronic locking system. When the keys is inserted into the lock, two ferrite-shrouded coils are placed in close proximity to each other to form what is essentially a transformer with an air gap. As with some electronic locks, Ktronic Keys does not have to make direct contact to transfer power to the lock. This system provides Controlled Access, Accountability, Physical Security, and System Management Software. More than just a way to protect your property, equipment and assets, Ktronic is also a business tool that can lead to a substantial return on investment.

The Ktronic system Provides:

Controlled Access – Keys are electronically programmed to open only specific locks during a designated schedule. Schedules may also contain an expiration point to completely disable the key until it is audited and reprogrammed.

Accountability – Audit information recorded in both the lock and key shows a time-and-date stamped record of every event, including authorized accesses and unauthorized attempts.

Electronic Rekeying & Scheduling – Respond quickly to security threats, lost or stolen keys, or personnel changes without the added cost of changing your locks and keys.

Easy Installation – Ktronic key provides all power to the cylinder, eliminating the need for any hard wiring or power supply. Simply remove the existing mechanical cylinder and install the Ktronic cylinder.

Physical Security – Ktronic products add a wide variety of intelligent features without compromising on physical security. Attack-resistant design and tamper-proof features provide strong protection against forced entry.

Efficient System Management – Ktronic software contains tools that will help you manage your security more efficiently. Flexible programming, scheduled access and full audit reports are offered with the convenience of web-based software.

Delivery

At Kenstan, we assemble every lock to order and strive to meet your requested in-house date.

Plating

The E^y line standard plating finish is Polished Nickel.

A wide range of special plating finishes is also available, including Satin Nickel, Polished Brass, Satin Brass, Statuary Bronze, Matte Black and Custom Finishes to match your showcase hardware. (Core will always be Satin Nickel finish)

Please note: Extended lead-time and plating lot charges may apply to Special and Custom finishes. Please call Kenstan for details.

* Extended lead-time and plating lot charges may apply to Special and Custom finishes. Please call Kenstan for details.

Item Number

To determine your item number enter the **RED** option code for each section as in the example below.

A	B	C	D	E	F	G	H
CL	EY	04	1203	PN	Y	W	106

A Lock Style

CL Cam Lock

B Core Type

EY Ktronic

C Housing Length

MAXIMUM MATERIAL THICKNESS

	WOOD	METAL	GLASS	BARREL LENGTH
04	3/4"	7/8"	3/4"	1-1/8"

D Cam Rotation

	LOCKED	OPEN
0306	3	6
0609	6	9
0912	9	12
1203	12	3

E Plating Finish

PN Polished Nickel
w/Satin Nickel Core

F Key Retaining

N No
Y Yes

G Material Installation

W Wood
M Metal
GR Glass with Round Hole
GD Glass with Double "D" Hole
O Other - No Mounting Hardware

H Cam Type

STRAIGHT

106	1-1/4"
107	1-3/8"
108	1-1/2"
110	1-3/4"

1/8" OFFSET

306	1-1/4"
308	1-1/2"

1/4" OFFSET

403	7/8"
404	1"
406	1-1/4"
408	1-1/2"
410	1-3/4"



Note: All Cam Locks come with a 1-1/4" Straight Cam unless a different cam is chosen.

Note: Keys are not included with this lock.
See page EY 11 to order keys.

Continued

Note: A 3/4" diameter hole is required to mount this lock.

C HOUSING LENGTH 04

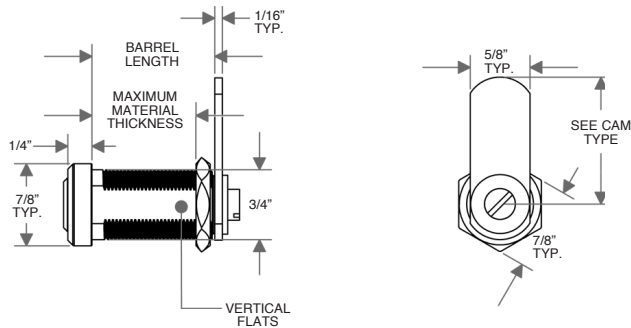

D CAM ROTATION (Front of lock shown)

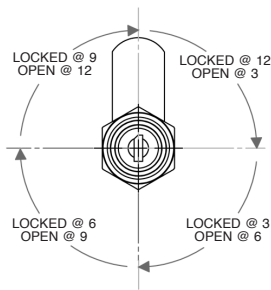

All Cam Rotations are 90 degree clockwise.

G WOOD INSTALLATION W

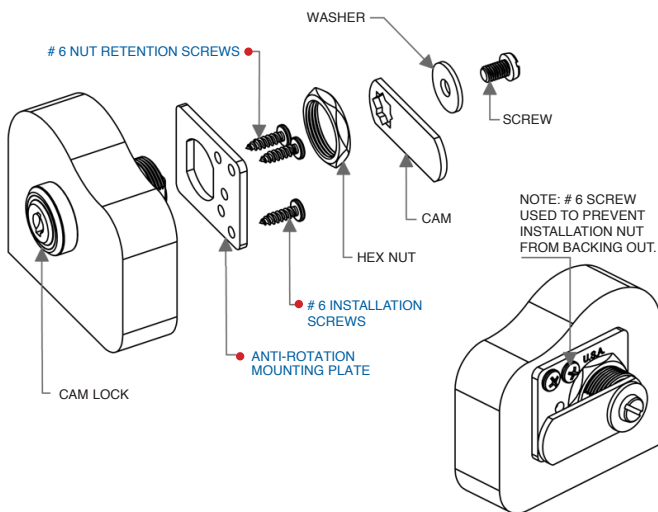

G METAL INSTALLATION M

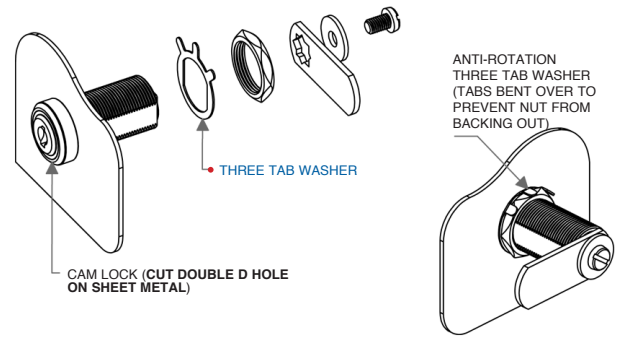

G GLASS INSTALLATION - ROUND HOLE GR

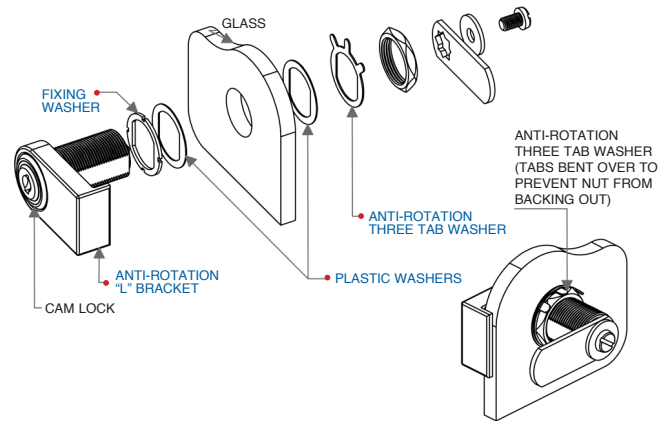

G GLASS INSTALLATION - DOUBLE D HOLE GD

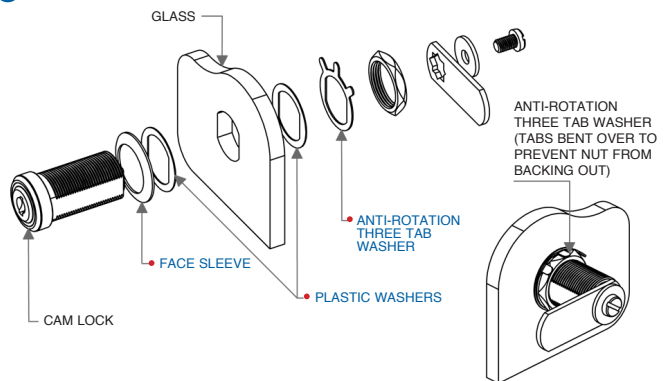

H CAM TYPES

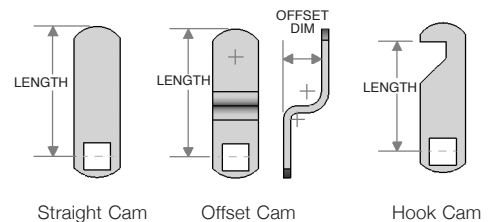

Note: All Offset cams are reversible.

Item Number

To determine your item number enter the **RED** option code for each section as in the example below.

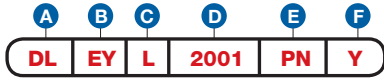

A Lock Style

DL Drawer/Door Lock

B Core Type

EY Ktronic

C Housing Length

L 1-7/16"

D Bolt Type

STRAIGHT BOLT

- 2001** 1-1/8"
- 2002** 1-3/4"
- 2003** 2-3/8"
- 2004** 3-3/16"

3/8" OFFSET BOLT

2205 1-11/16"

DIECAST SPRING BOLT

3209 1-3/8" Std.

SLIDING SPRING BOLT

- 3410** 1-3/8" Left
- 3411** 1-3/8" Right

E Plating Finish (Housing)

Core will always be Satin Nickel finish. Extended lead-time and plating lot charges **may** apply to Special and Custom finishes.

- | | | |
|----------------|-----------|-----------------|
| Special Finish | PN | Polished Nickel |
| | SN | Satin Nickel |
| | PB | Polished Brass |
| | SB | Satin Brass |
| | BL | Matte Black |
| | ST | Statuary Bronze |
| | CF | Custom Finish |

F Key Retaining

- N** No
- Y** Yes

Note: Keys are not included with this lock. See page EY 11 to order keys.



"Throw" (distance bolt travels from the locked to unlocked position) is 7/16". All dimensions shown are in the locked position.

D STRAIGHT BOLT VERTICAL

C HOUSING LENGTH

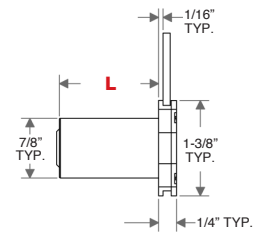
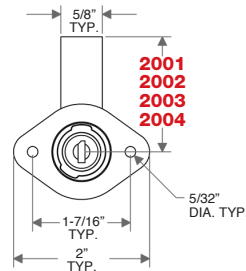

D 3/8\"/>

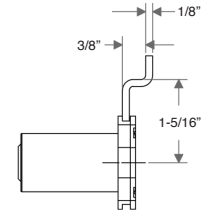
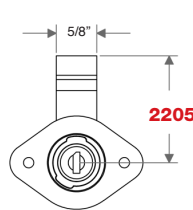

D DIECAST SPRING BOLT VERTICAL (3/16\"/>

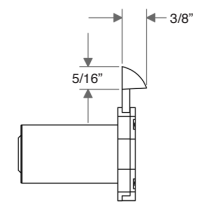
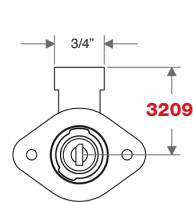

D SLIDING SPRING BOLT INVERTED

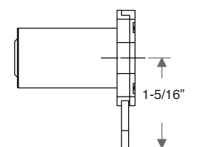
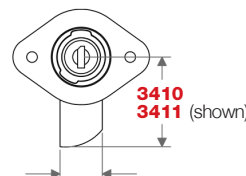

Price List and Data Sheet

Item Number

To determine your item number enter the **RED** option code for each section as in the example below.

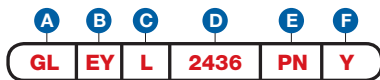

A Lock Style
GL Gang Lock

B Core Type
EY Ktronic

C Housing Length
L 1-7/16"

D Mount Style/Bar Length

Notch for Pin must be on Bottom of Drawer	FRONT MOUNT LOCKED UP	
	2424	24"
	2436	36"
	2448	48"
	24CL	Custom
	24NO	No Bar
	SIDE MOUNT LOCKED UP	
	2624	24"
	2636	36"
	2648	48"
26CL	Custom	

E Plating Finish (Housing)
Core will always be Satin Nickel finish. Extended lead-time and plating lot charges may apply to Special and Custom finishes.

Special Finish	PN	Polished Nickel
	SN	Satin Nickel
	PB	Polished Brass
	SB	Satin Brass
	BL	Matte Black
	ST	Statuary Bronze
	CF	Custom Finish

F Key Retaining

N	No
Y	Yes

Note: Keys are not included with this lock. See page EY 11 to order keys.

Throw (distance bolt travels from the locked to unlocked position) is 7/16".

FRONT MOUNT - FRONT VIEW

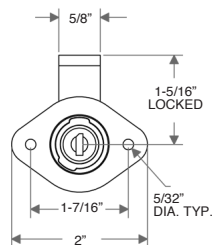

FRONT MOUNT - SIDE VIEW

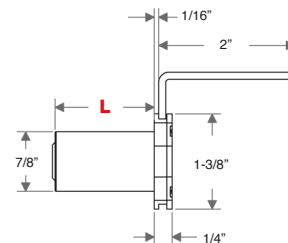

FRONT MOUNT (Shown with a Gang 3C Kit)

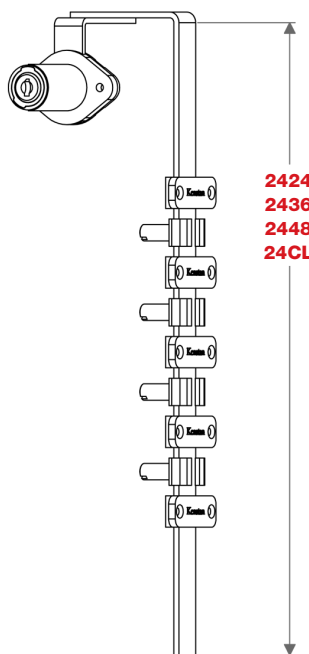

SIDE MOUNT (Shown with a Gang 3C Kit)

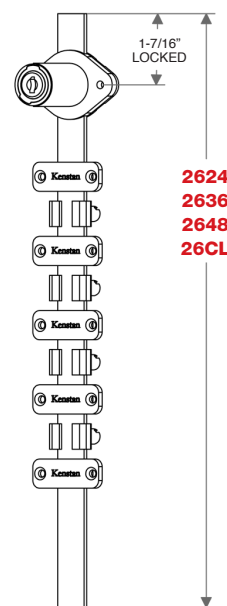

Gang Lock Packages

To determine your item number enter the **RED** option code for each section as in the example below.

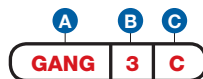

GANG 3C A kit with three adjustable stops, three 1-1/8" pins, three lock washers, and four closed bar guides.

A Package
GANG

B Number of Drawers

2
3
4

C Pin Length

A	5/8"
B	3/4"
C	1-1/8"
D	1-7/8"

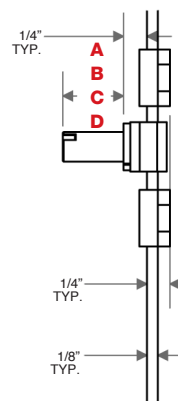

Item Number

To determine your item number enter the **RED** option code for each section as in the example below.

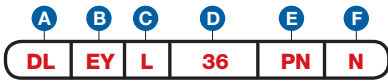

- A Lock Style**
DL Drawer/Door Lock

- B Core Type**
EY Ktronic

- C Housing Length**
L 1-7/16"

- D Bolt Type**
SNAP BOLT
36 3/4"

- E Plating Finish (Housing)**
Core will always be Satin Nickel finish.
Extended lead-time and plating lot charges **may** apply to Special and Custom finishes.

Special Finish	}	PN Polished Nickel
		SN Satin Nickel
		PB Polished Brass
		SB Satin Brass
		BL Matte Black
		ST Statuary Bronze
CF Custom Finish		

- F Key Retaining**
N No

Note: Keys are not included with this lock. See page EY 11 to order keys.

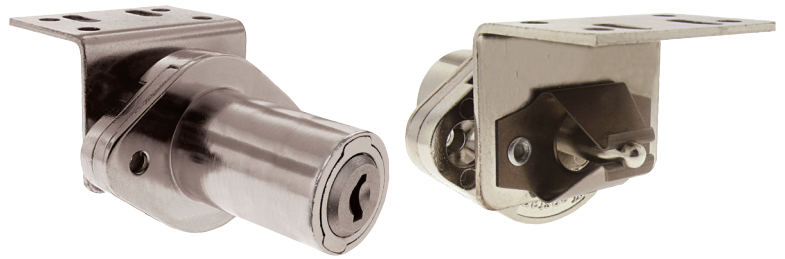

All dimensions shown are in the locked position.

HOUSING LENGTH

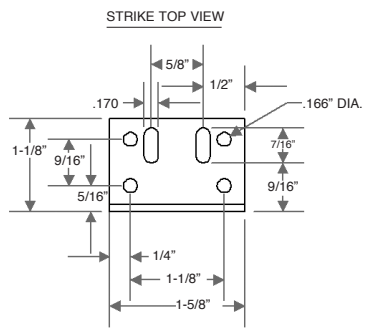
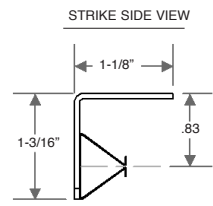
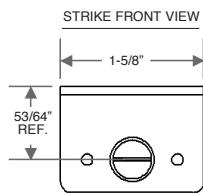
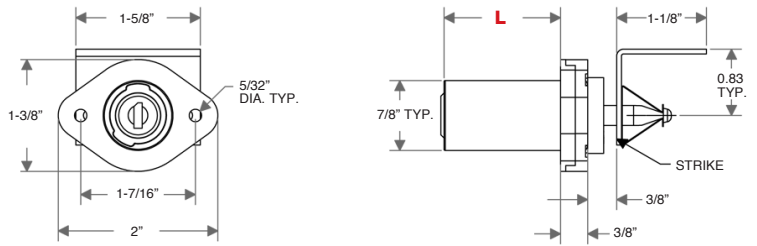

Price List and Data Sheet

Item Number

To determine your item number enter the **RED** option code for each section as in the example below.

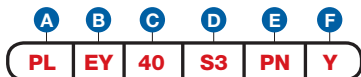

A Lock Style
PL Plunger Lock

B Core Type
EY Ktronic

C Housing Style
40 Oval Flange

D Plunger Type/Length

S SERIES

S1 5/16"
S2 7/16"
S3 5/8"

ROUND SERIES

R1 5/16"
R2 7/16"
R3 5/8"

ROUND EXTENDED SERIES

R4 1-3/16"
R5 1-5/16"
R6 1-11/16"
R7 2-7/16"

E Plating Finish (Housing)

Core will always be Satin Nickel finish. Extended lead-time and plating lot charges **may** apply to Special and Custom finishes.

Special Finish	PN	Polished Nickel
	SN	Satin Nickel
	PB	Polished Brass
	SB	Satin Brass
	BL	Matte Black
	ST	Statuary Bronze
	CF	Custom Finish

F Key Retaining

N No
Y Yes

Note: Keys are not included with this lock. See page EY 11 to order keys.



All dimensions shown are in the locked position.

D S SERIES

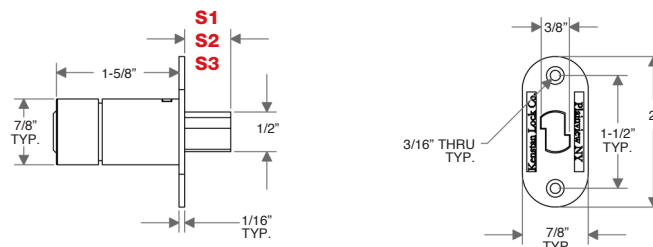

D ROUND SERIES

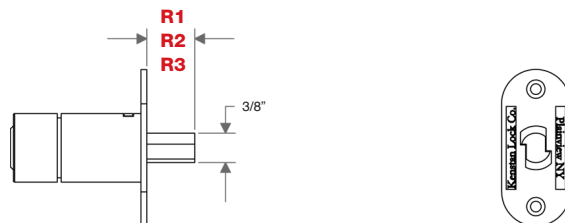

D ROUND EXTENDED SERIES (Plunger travels 5/8")

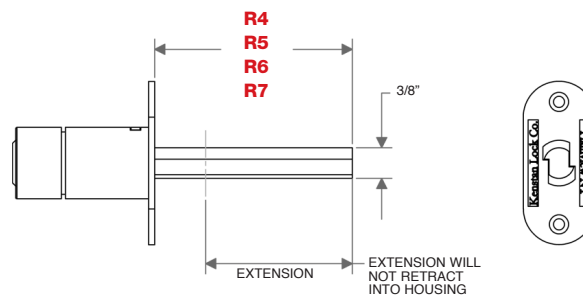

Item Number

To determine your item number enter the **RED** option code for each section as in the example below.

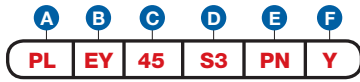
**A Lock Style**

PL Plunger Lock

B Core Type

EY Ktronic

C Housing Style

45 No Flange

D Plunger Type/Length**S SERIES**

S1 5/16"

S2 7/16"

S3 5/8"

ROUND SERIES

R1 5/16"

R2 7/16"

R3 5/8"

ROUND EXTENDED SERIES

R4 1-3/16"

R5 1-5/16"

R6 1-11/16"

R7 2-7/16"

E Plating Finish (Housing)

Core will always be Satin Nickel finish. Extended lead-time and plating lot charges **may** apply to Special and Custom finishes.

Special Finish	PN	Polished Nickel
	SN	Satin Nickel
	PB	Polished Brass
	SB	Satin Brass
	BL	Matte Black
	ST	Statuary Bronze
	CF	Custom Finish

F Key Retaining

N No

Y Yes

Note: Keys are not included with this lock. See page EY 11 to order keys.

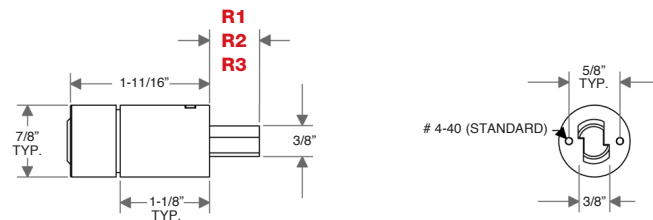
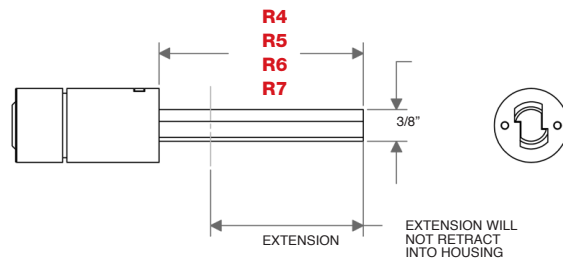

All dimensions shown are in the locked position.

D R SERIES**D ROUND EXTENDED SERIES (Plunger travels 5/8")**

Price List and Data Sheet

Item Number

To determine your item number enter the **RED** option code for each section as in the example below.

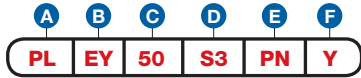

A Lock Style
PL Plunger Lock

B Core Type
EY Ktronic

C Housing Style
50 Round Flange

D Plunger Type/Length

S SERIES

S1 5/16"
S2 7/16"
S3 5/8"

ROUND SERIES

R1 5/16"
R2 7/16"
R3 5/8"

ROUND EXTENDED SERIES

R4 1-3/16"
R5 1-5/16"
R6 1-11/16"
R7 2-7/16"

E Plating Finish (Housing)

Core will always be Satin Nickel finish. Extended lead-time and plating lot charges **may** apply to Special and Custom finishes.

Special Finish	{	PN Polished Nickel
		SN Satin Nickel
		PB Polished Brass
		SB Satin Brass
		BL Matte Black
		ST Statuary Bronze
CF Custom Finish		

F Key Retaining

N No
Y Yes

Note: Keys are not included with this lock. See page EY 11 to order keys.



All dimensions shown are in the locked position.

D S SERIES

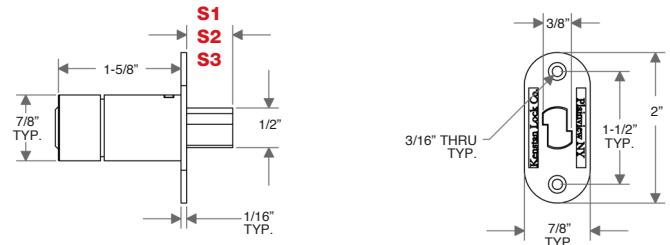

D ROUND SERIES

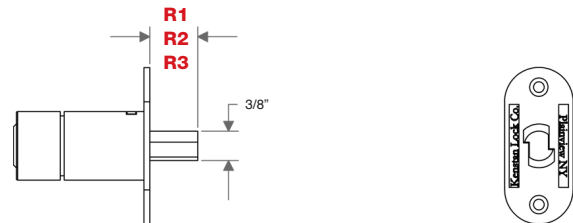

D ROUND EXTENDED SERIES (Plunger travels 5/8")

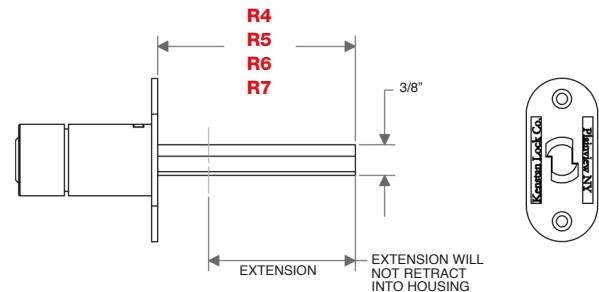

Padlock

Item Number

A	EY	70	PAD	LCK	01	BL
---	----	----	-----	-----	----	----



Activation Plug

Item Number

A	EY	XX	PLG	ACT	XX	PN
---	----	----	-----	-----	----	----



An Activation plug is a small device used to “renew/activate” an expired key. This device is normally held by a manager. An activation plug is useful if you cannot access your Sync Station.

Multi-function Station

Item Number

A	EY	XX	MFS	XXX	XY	BL
---	----	----	-----	-----	----	----



The base multi-function station can be used for key activation using a user PIN and USB or both. The activation function may be key-powered or with a battery boost supporting a larger display and keyboard backlight. With plug-in modules the station may also be used as a GSM sync station or remote key or site monitoring depending on installed hardware. The station may be charged or powered using a standard 5V USB charger with a micro-B USB connector.

Features

- Emergency key powered
- Mobile, desk or wall-mounted
- Battery backup
- Stand-alone
- Secure communication with server



Operating Key



Key Usage

			Short "beep": key is authorized, turn
			All red for one second "beep": Key is not authorized, check permissions.
			Third light flashes every 10 seconds on standby: Battery is going flat, replace battery
			Middle light one second "beep beep" when inserted OR flashes every 10 seconds on standby: Key is out of time window, sync the key

Ktronic Key supports online management operations such as issue, revoke, view usage history, grant access, customized configurations of LED's and beeps or completely disable.

No need to charge keys every day, Ktronic keys are powered by an easily replaceable coin cell CR2032 battery that is good for about 2 years or **50,000** lock accesses.

Features

- Low battery indicator
- Online access management
- Contactless communication
- Duplication only available through authorized channels
- Power supply for the lock
- Power supply for the Sync Station if needed

Setup Fee

Kenstan can help you setup your locks and keys via online software for a small fee. Fee will be based on your system size.

Hosting Fee

The cost of annual hosting is based on the number of locks in your system. Kenstan will wave the hosting fee for the first year.

Warranty

Kenstan Ktronic lock and key warrants, for a period of 2 year from delivery, that our products are free from defects in material and workmanship and makes no other warranties, expressed or implied, including but not limited to the degree of security or the purchaser's application or use of our product. Kenstan Lock Co. will not warranty any locks or parts that were modified outside of our factory. In the event of a product defect, Kenstan shall only be responsible to the extent of the cost of our product, and will not accept any claims for labor or loss of merchandise.

- 1. Pricing:** Kenstan Lock reserves the right to institute price adjustments based upon fluctuation of material costs without prior notice. Orders, or balances of orders, that have not shipped within 6 months from the original order date may be subject to a price review.
- 2. Payment Terms:** Payment must be made at time of purchase, unless otherwise approved by Kenstan with terms of Net 30 Days from the date of the invoice. A service charge of 1.5% per month will be charged on overdue accounts.
- 3. Shipping:** Please be sure to specify your preferred shipping method on every order. For all orders received without shipping instructions, Kenstan will use our discretion to make carrier selection based upon the most economical method of shipment available to meet your required in house date. Kenstan is not responsible for risk of loss or damage to products in transit with the selected carrier.
- 4. Deliveries:** At Kenstan, we assemble every lock to order and strive to meet your requested in-house date. Our standard lead time is to ship within two weeks from the receipt of your order. Rush orders and emergency services are available. Unless specifically prohibited in writing by the purchaser, Kenstan reserves the right to make partial shipments of any order.
- 5. Inspection:** Kenstan Lock inspects all products in accordance with our standard quality control procedures. Upon receipt and inspection by the purchaser, any parts proven to be defective or not as ordered may be returned to Kenstan for repair or replacement following the conditions in the "Returned Goods" section (#6) below.
- 6. Returned Goods:** Product replacement or account credit for any returned goods will be made solely at the discretion of Kenstan and will only be accepted upon the issuance of a Return Authorization number from Kenstan's Customer Service Department. Merchandise proven to be defective, due to faulty material and/or workmanship, may be returned for full replacement or credit. Any product ordered incorrectly by the customer may be accepted for return and subject to a 50% handling charge. Locks made with special or out-of production parts are not returnable, unless prior arrangements have been made. Returned merchandise that is damaged in transit, due to inadequate return packaging, will not be accepted.
- 7. Warranty:** Kenstan Lock warrants, for a period of one year from delivery, that our products are free from defects in material and workmanship and makes no other warranties, expressed or implied, including but not limited to the degree of security or the purchaser's application or use of our product. Kenstan Lock Co. will not warranty any locks or parts that were modified outside of our factory. In the event of a product defect, Kenstan shall only be responsible to the extent of the cost of our product, and will not accept any claims for labor or loss of merchandise.
- 8. Cancellation:** If all or any part of an order is cancelled before the completion of the product assembly by Kenstan, the purchaser shall be responsible for payment of all assembled items as well as any special parts ordered for items remaining unassembled at the time of cancellation. If pricing on the original order was based upon Kenstan's quantity discount, a partial cancellation may affect the pricing on items already shipped and invoiced and a price adjustment will be made.
- 9. Catalog Dimensions and Sample Policy:** Please be aware that all lock and part drawing dimensions carry a tolerance of plus or minus 1/16" and are for reference only. Please contact us for actual dimensions. All specifications are subject to change without notice. Samples products are available upon request.